

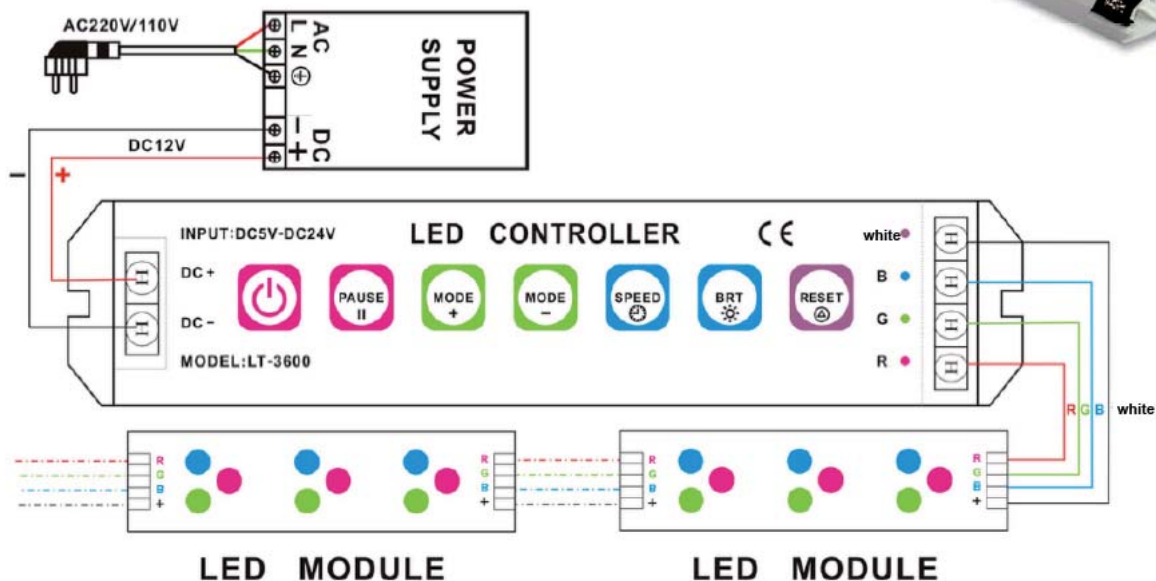

















Connected to LED RGB module;



ON/OFF, PAUSE, MODE+, MODE-, SPEED, BRT, RESET

Sign	Button	RC	Description
	ON/OFF		ON/OFF: Turn on/off the controller  Any button can start the controller at off status
	PAUSE	2	Pause: Press this button will rest at current color, press it again, will continue to change.
	MODE+	3	Mode+: Press this button to select next mode

	MODE-	4	Mode-: Press this button & back to previous mode
	SPEED	5	Speed: Press this button to select 1-8 speed changing levels.
	BRT	6	Brightness: Press this button to select 1-8 brightness adjustment levels.
	RESET	1	Reset: Press it a second, enter Cycle mode; Press this button over 3 seconds, if LED flickers twice, it means it has restored to Default status successfully.

Sign	Button	Description
	ON/OFF	ON/OFF: Turn on/off the controller  Any button can start the controller at off status
	PAUSE	Pause: Press this button will rest at current color, press it again, will continue to change.
	MODE+	Mode+: Press this button to select next mode
	MODE-	Mode-: Press this button & back to previous mode
	SPEED	Speed: Press this button to select 1-8 speed changing levels.
	BRT	Brightness: Press this button to select 1-8 brightness adjustment levels.
	RESET	Reset: Press it a second, enter Cycle mode; Press this button over 3 seconds, if LED flickers twice, it means it has restored to Default status successfully.

Tables of changing modes

Sequence	Modes	Description
1	Static red	Supports Brightness adjustment
2	Static green	Supports Brightness adjustment
3	Static blue	Supports Brightness adjustment
4	Static yellow	Supports Brightness adjustment
5	Static purple	Supports Brightness adjustment
6	Static cyan	Supports Brightness adjustment
7	Static white	Supports Brightness adjustment
8	3 color skipping	Red, green and blue 3-color skipping
9	7 color skipping	Red, green, blue, yellow, purple, cyan, white 7-color shipping
10	White color strobe	White (with all red, green and blue on) strobe
11	3 color smooth	Red, green and blue 3-color gradual changes
12	Full color smooth	All 7-color gradual changes
13	RG color smooth	Red, green 2-color gradual changes
14	R B color smooth	Red, blue 2-color gradual changes
15	GB color smooth	Green, blue 2-color gradual changes
16	White color fade & change	white (with red, green & blue on) gradual bright & fade change
17	Great cycle	All changing modes overlap cycle